

*boire un verre (ou deux)
après (ou avant) le sport
ou juste comme ça*

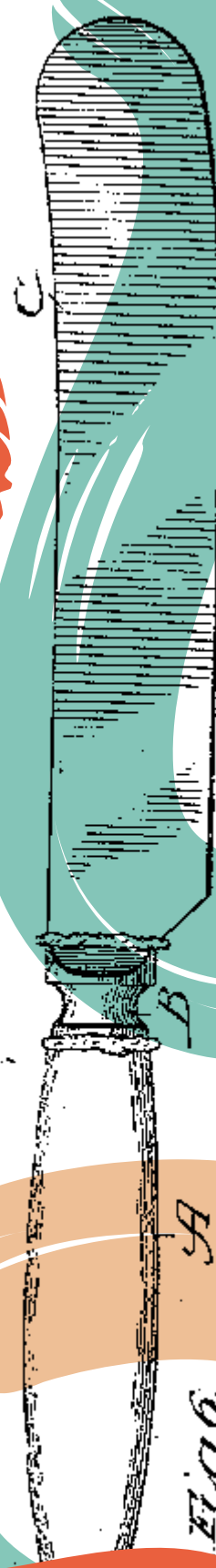
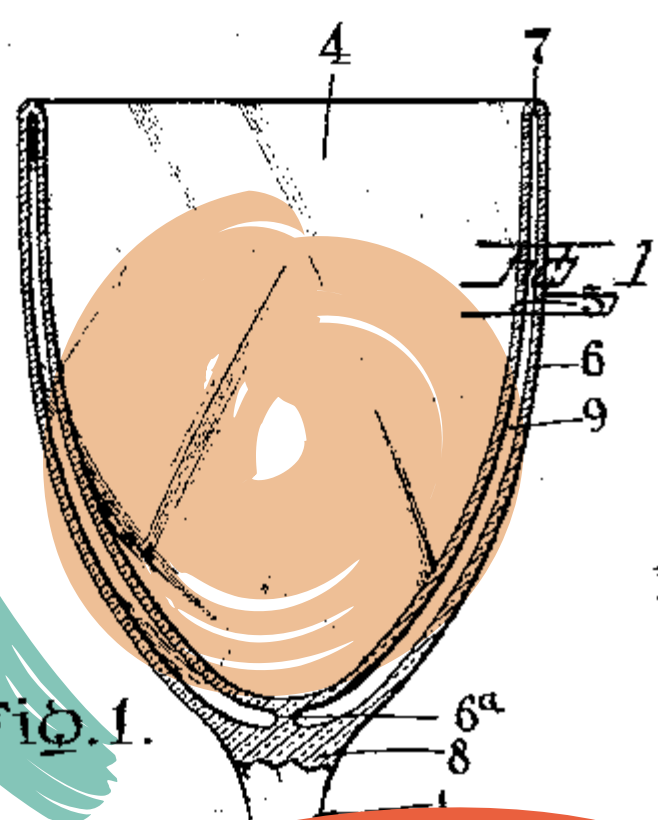

*manger des produits
de nos fermes et
de notre boucherie**

**ou de partenaires producteurs
sélectionnés*

bistro pilko

—FIG. 1.—

*fêter, célébrer, quand
vous voulez, et même
danser, les vendredis
et les samedis*



manger

softs

bières

cocktails

vins

alcools

infos club

**Cliquez pour atteindre*



*Les horaires de la cuisine
se trouvent en dernière page
de cette carte.*

Fig 1

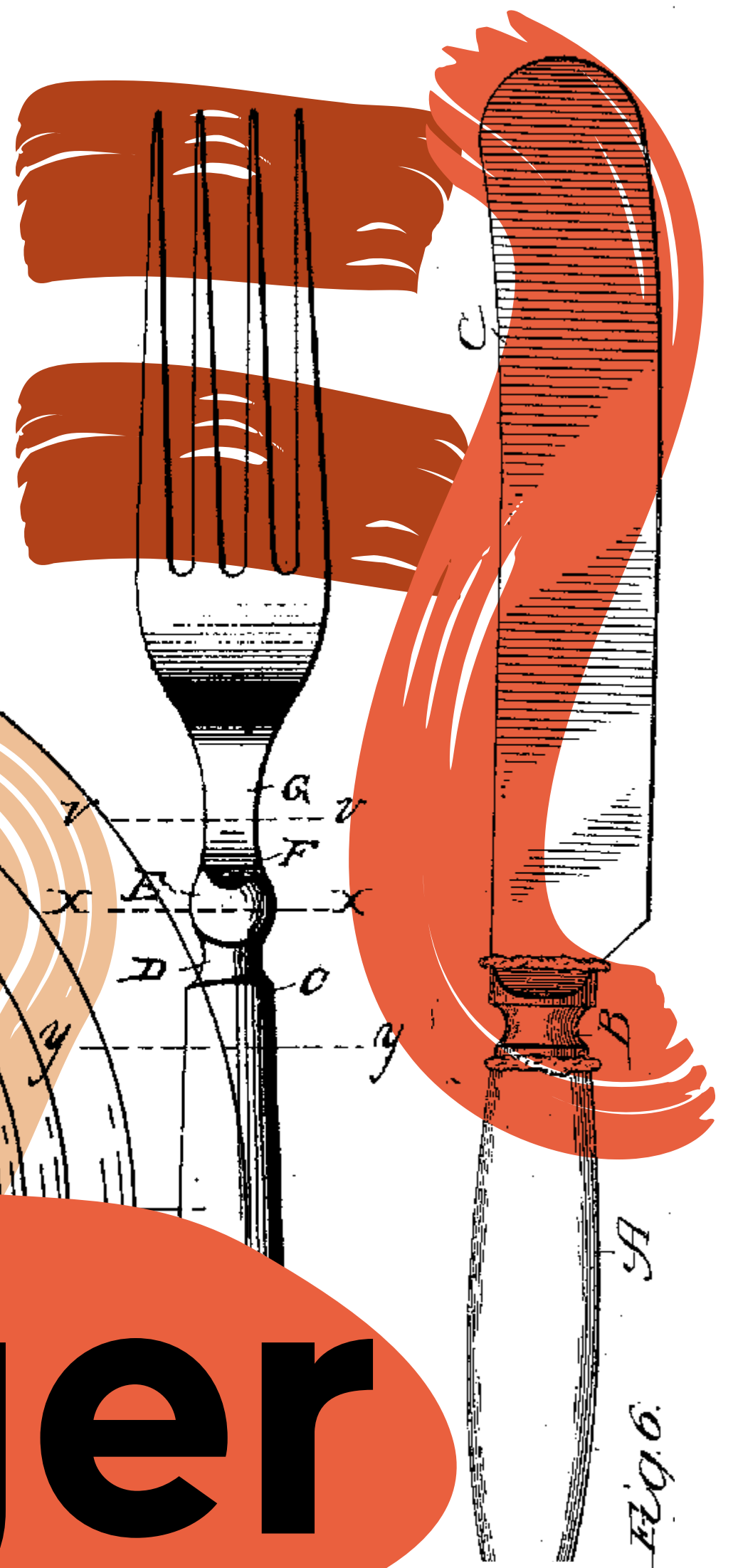

pour manger

à partager *(ou pas)*

FRITES | PATATES DOUCES 5

sauce au choix

HOUMOUS DU MOMENT 9

zaatar, crackers

PORTION DE FROMAGE 8

moutarde de Dijon, sel de céleri

ASSIETTE 'TEROIR' DU MOMENT 19

charcuteries de notre boucherie, pain toasté

NACHOS 10

sauce Cheddar, jalapeños

PINSA ROMANA 12.5

Mozzarella, jambon cuit de notre boucherie

FINGERS DE VOLAILLE 12.5

mayonnaise pimentée

NEMS AU POULET (3pcs) 15

sauce soja sésame

*Information sur les allergènes disponible sur demande, la
composition des plats peut varier.*



plats

SALADE ITALIENNE	15
<i>Buratta, olives noires, croûtons, tomates sechées, basilic</i>	
SALADE CÉSAR	18.5
<i>Poulet croquant, laitue romaine, oeuf dur, croûtons, parmesan</i>	
AMÉRICAIN PRÉPARÉ MAISON	19
<i>Boeuf de notre ferme, frites, mayonnaise, salade</i>	
SPAGHETTI BOLOGNESE MAISON	16
<i>Fromage râpé</i>	
BOULETTES MAISON	18
<i>Sauce tomate, frites, salade</i>	
ROCKY'S PIZZA 4 FROMAGES	16
<i>Taleggio, Scamorza, Gorgonzola, Emmental</i>	
ROCKY'S PIZZA PROSCIUTTO	16
<i>Prosciutto, champignons</i>	
CHICKENBURGER.....	18.5
<i>Suprême de poulet fermier pané, tomates, salade, sauce Giant maison, frites (supplément bacon + 1€)</i>	
CHEESEBURGER TERO.....	18.5
<i>pati pur boeuf de notre ferme, tomate, salade, cheddar, sauce Giant maison, frites (supplément bacon + 1€)</i>	

desserts

MOELLEUX AU CHOCOLAT	9
<i>crème anglaise, chantilly</i>	
GAUFRE DE BRUXELLES	9
<i>chantilly, sucre impalpable</i>	

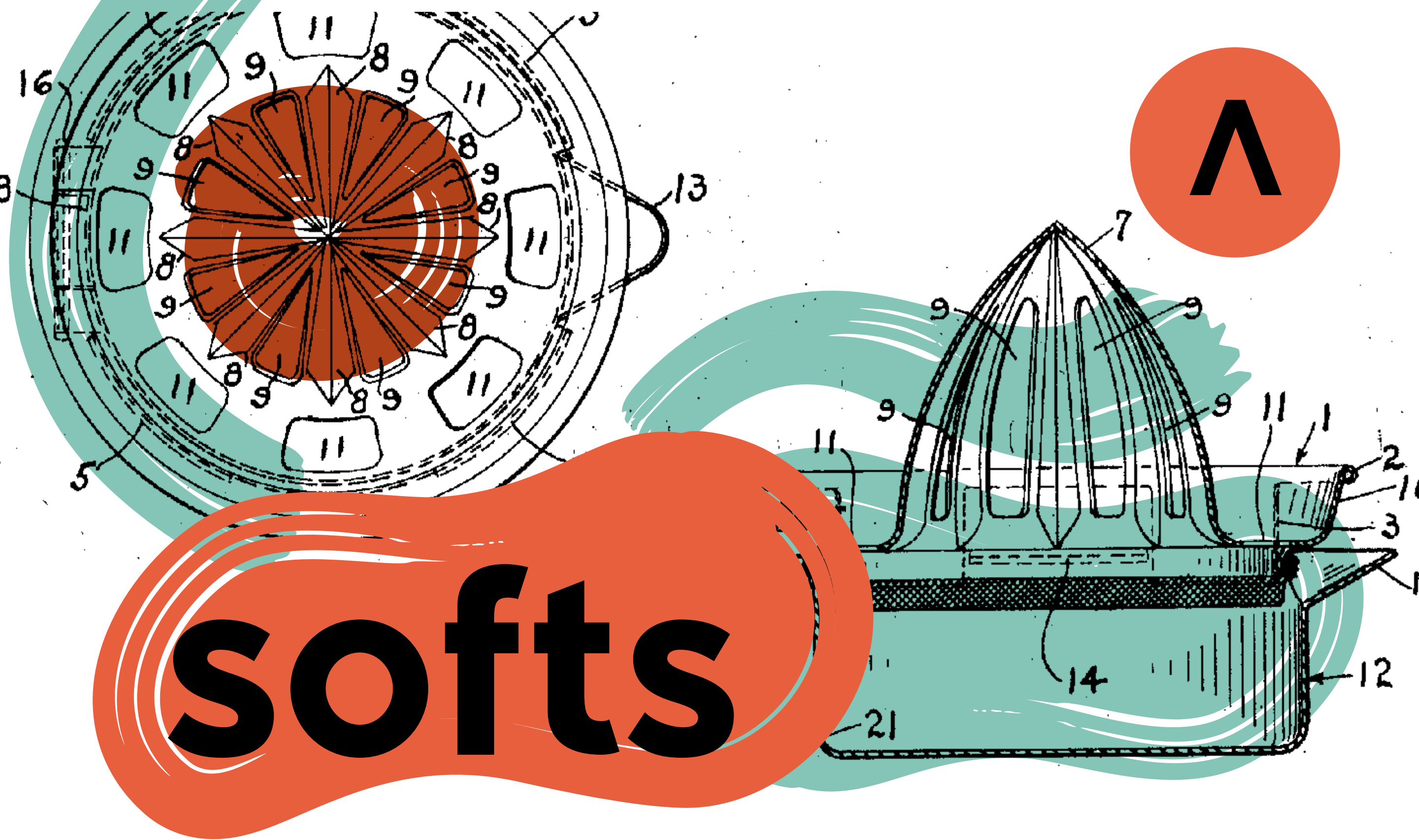

Lemonaid+	4.60
<i>Lime / Ginger / Blood Orange</i>	
Charitea Maté	4.60
Kult Water Kefir	4.60
<i>Passion & Hops / Ginger & Lemon / Yuzu & Mandarin</i>	
Ossa.....	4.60
<i>Ginger & Lemon</i>	
Big Tom.....	4.60
<i>Tomato Juice</i>	
Vit Hit	5.70
<i>Perform (Mango & Passion Fruit) / Boost (Berry)</i>	
Eau Bru 25 cl 50cl.....	3.20 6.00
<i>Plate / Pétillante</i>	
Minute Maid	3.20
<i>Orange / Pomme / Pomme & Cerise</i>	
Coca Cola	3.20
<i>Original / Zero</i>	
Sprite	3.20
Fanta.....	3.20
Ice Tea.....	3.20
<i>Original / Peach</i>	
Schweppes Tonic.....	3.20
Aquarius.....	3.60
<i>Lemon / Red Peach / Orange</i>	

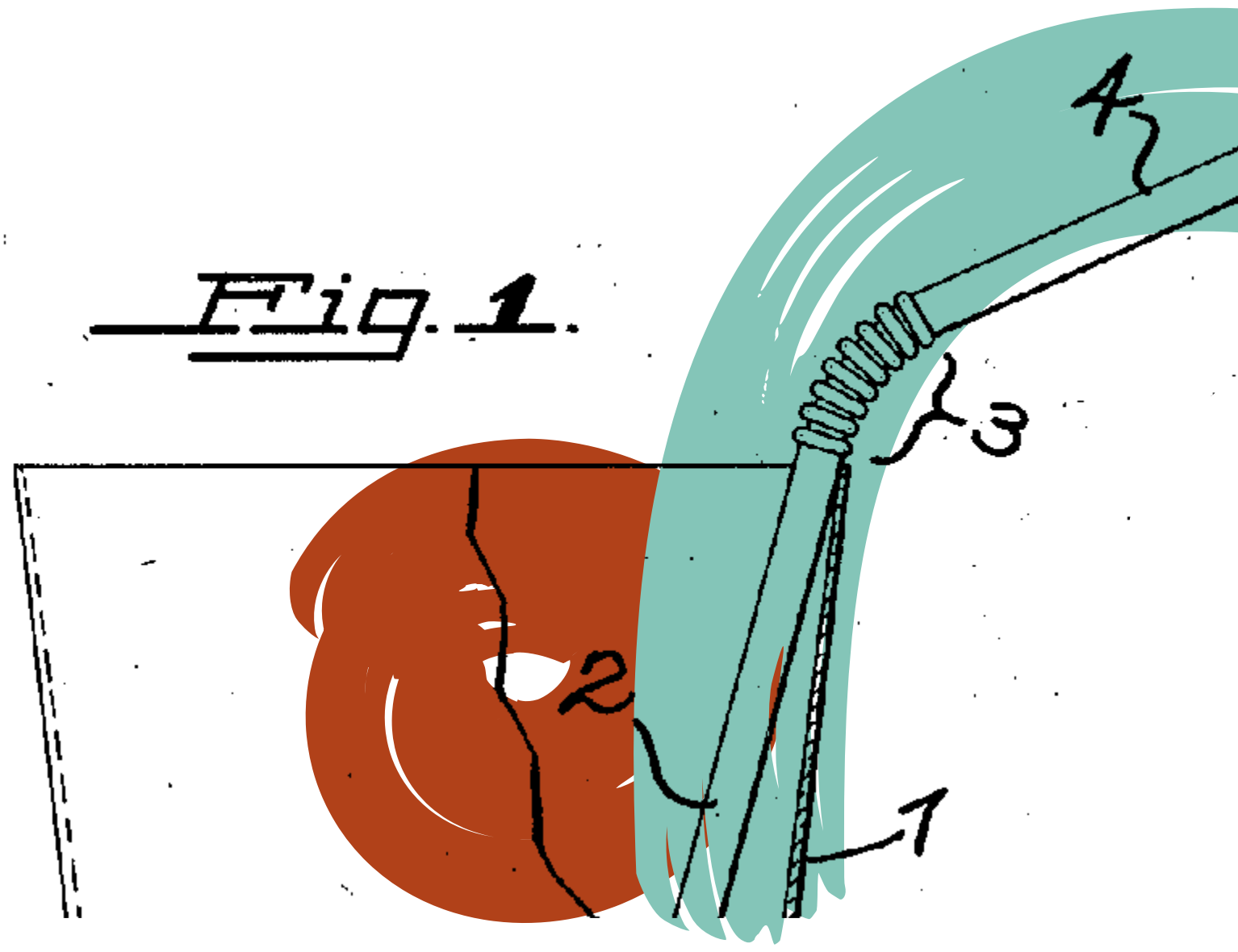

Red Bull	4.60
<i>Original / Sugar-free / Watermelon / Juneberry</i>	
Fever Tree	4.60
<i>Tonic / Mediterranean Tonic / Ginger Ale</i>	
<i>Ginger Beer / Pink Grapefruit / Raspberry & Rhubarb</i>	
Un Chose	5.50
<i>Tonic, Pamplémousse Rose Bio Pajottenlander</i>	

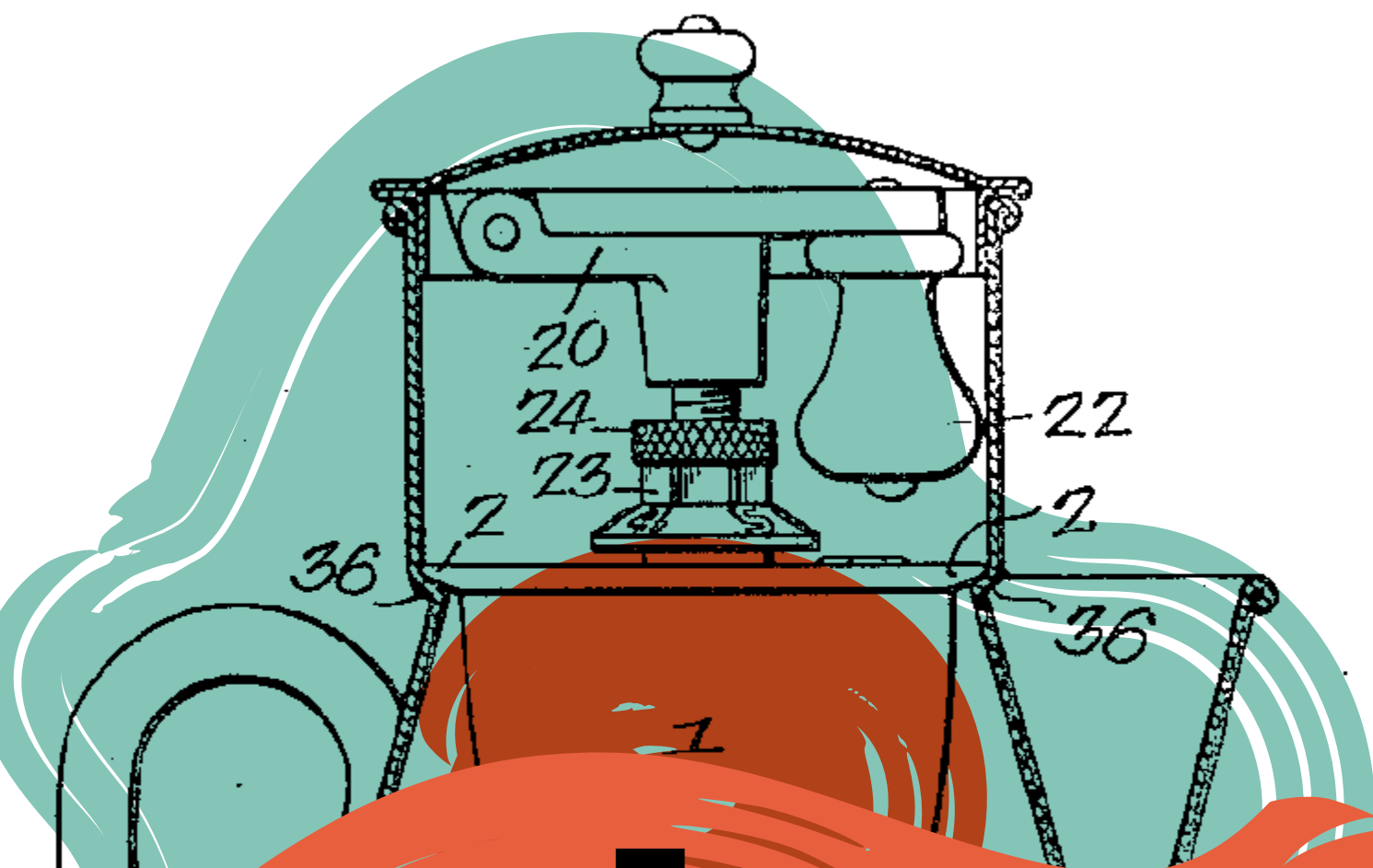

chaud

Lungo Espresso Americano	3.20
Cappuccino	3.70
Latte Machiato	4.00
Chocolat chaud	4.00
Thé	3.20
Thé Menthe Fraîche	3.70



FIG. 1

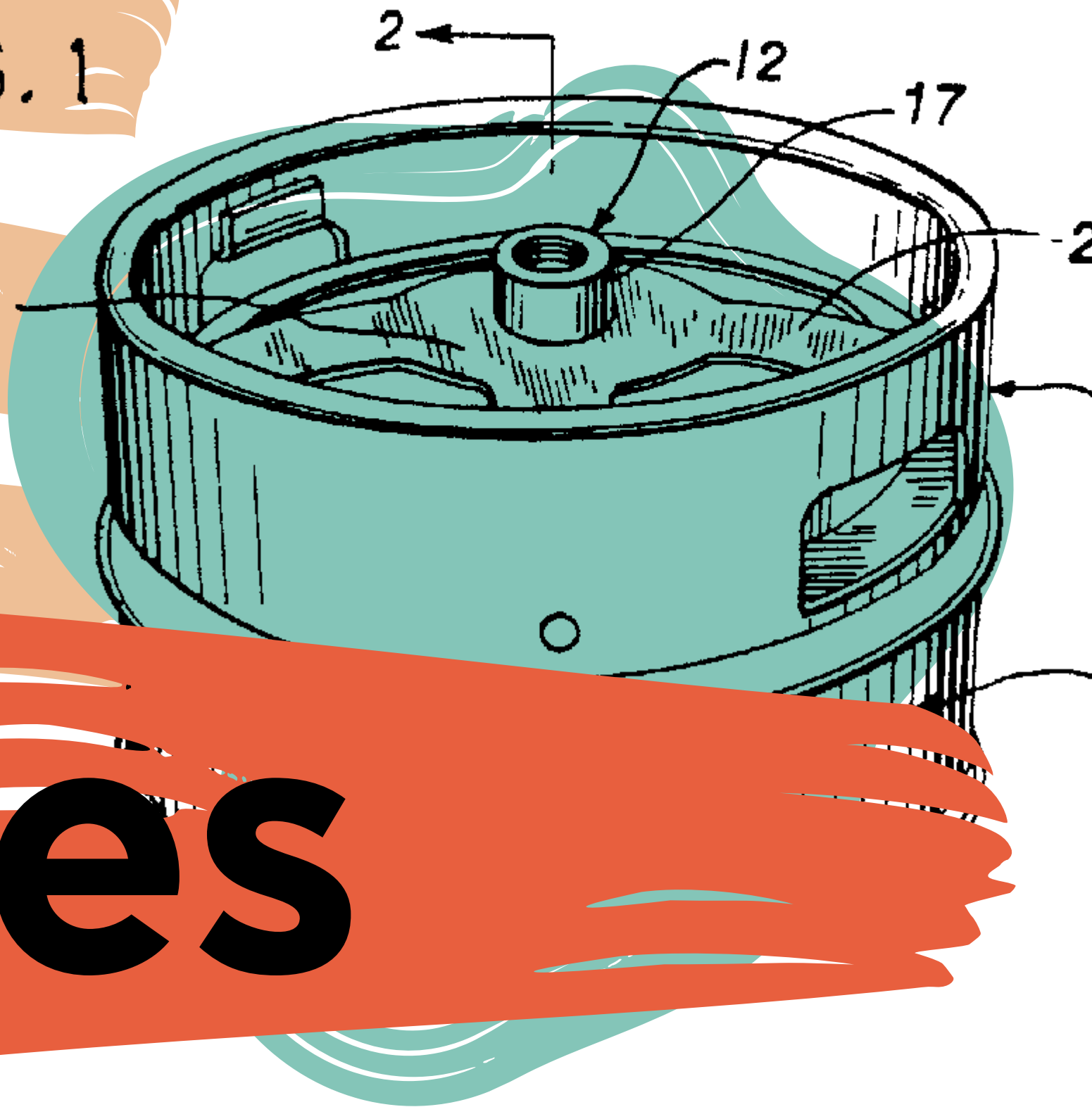
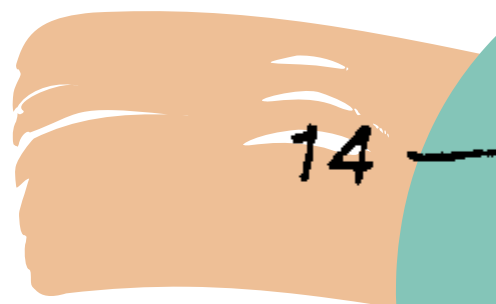

bières

au fût

Stella Artois 25cl 50cl	3.20 6.00
Liefmans 25cl.....	4.00
Hoegaarden Blanche 25cl 50cl.....	4.00 7.00
Goose IPA 25cl 50cl.....	4.50 8.00
Triple Karmeliet 33cl.....	5.00

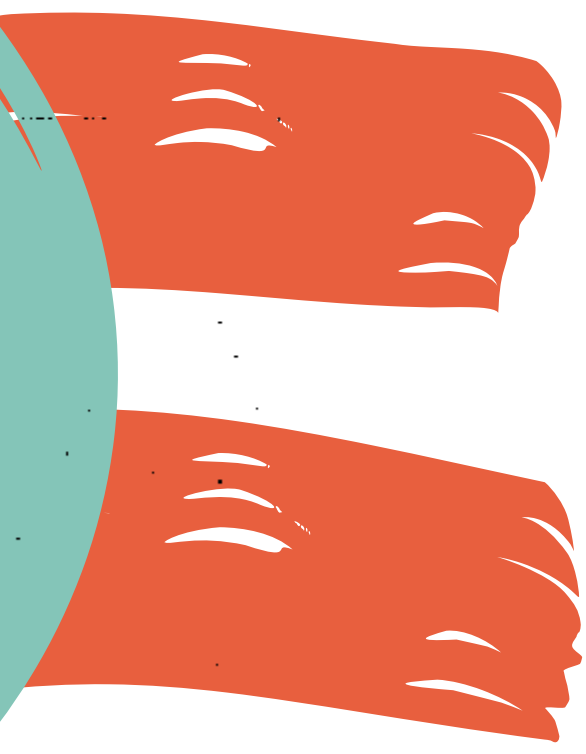
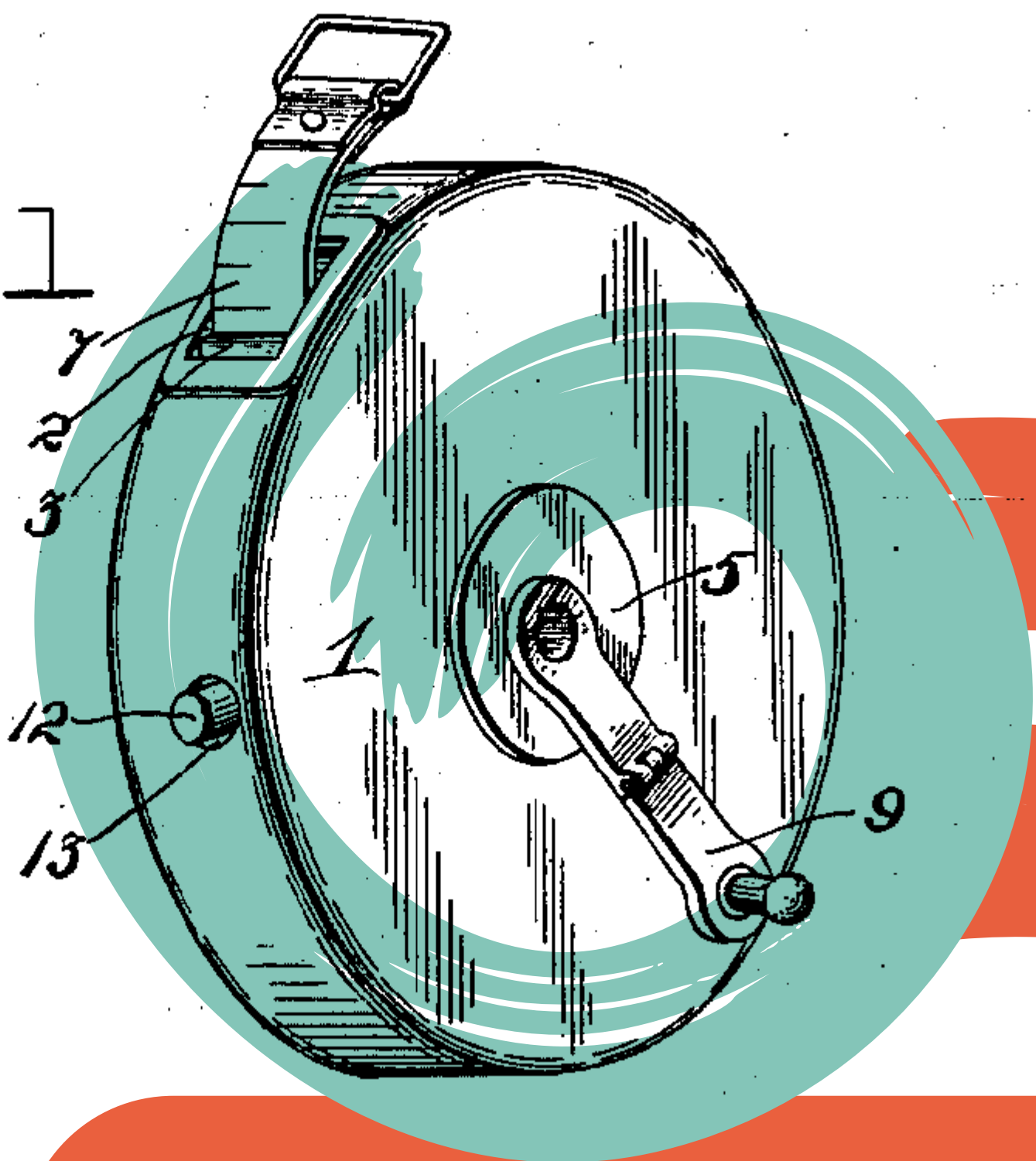

Mètre Stella 10 bières + 1 offerte 32.00

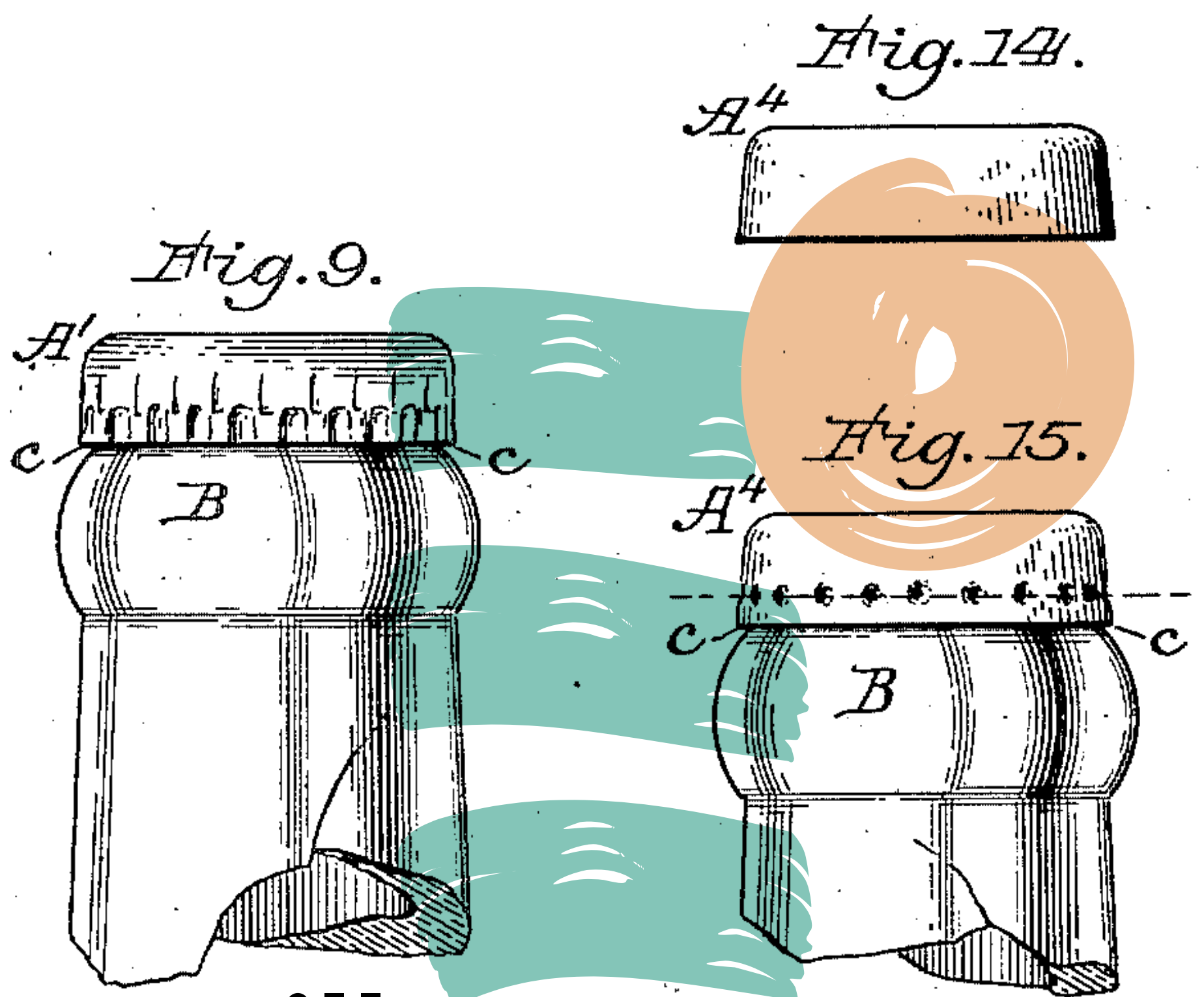

en bouteille

Stella Artois 0.0	3.20
Liefmans 0.0.....	3.50
Lefse Blonde 0.0.....	4.50
Corona 0.0	5.20
Trottinette IPA 0.4 33cl	5.20
Hoegaarden Rosée 25cl.....	4.00
Lefse Blonde 33cl.....	5.00
Bertinchamps Légère.....	5.00
Bertinchamps Pamplousse	5.20
Duvel Blonde / 6,66 33cl	5.20
Chouffe Blonde / Soleil 33cl.....	5.20
Surrealiste Pale Ale 33cl	5.20
Jungle Joy by Brussels Beer Project 33cl	5.20
Vedett IPA 33cl	5.20
Corona 33cl.....	5.20
The Good Cider 33cl.....	5.20
Salitos 33cl.....	5.20

BUCKET SALITOS/CORONA 5+1 gratuit ... 26.00

Λ

FIG. 12

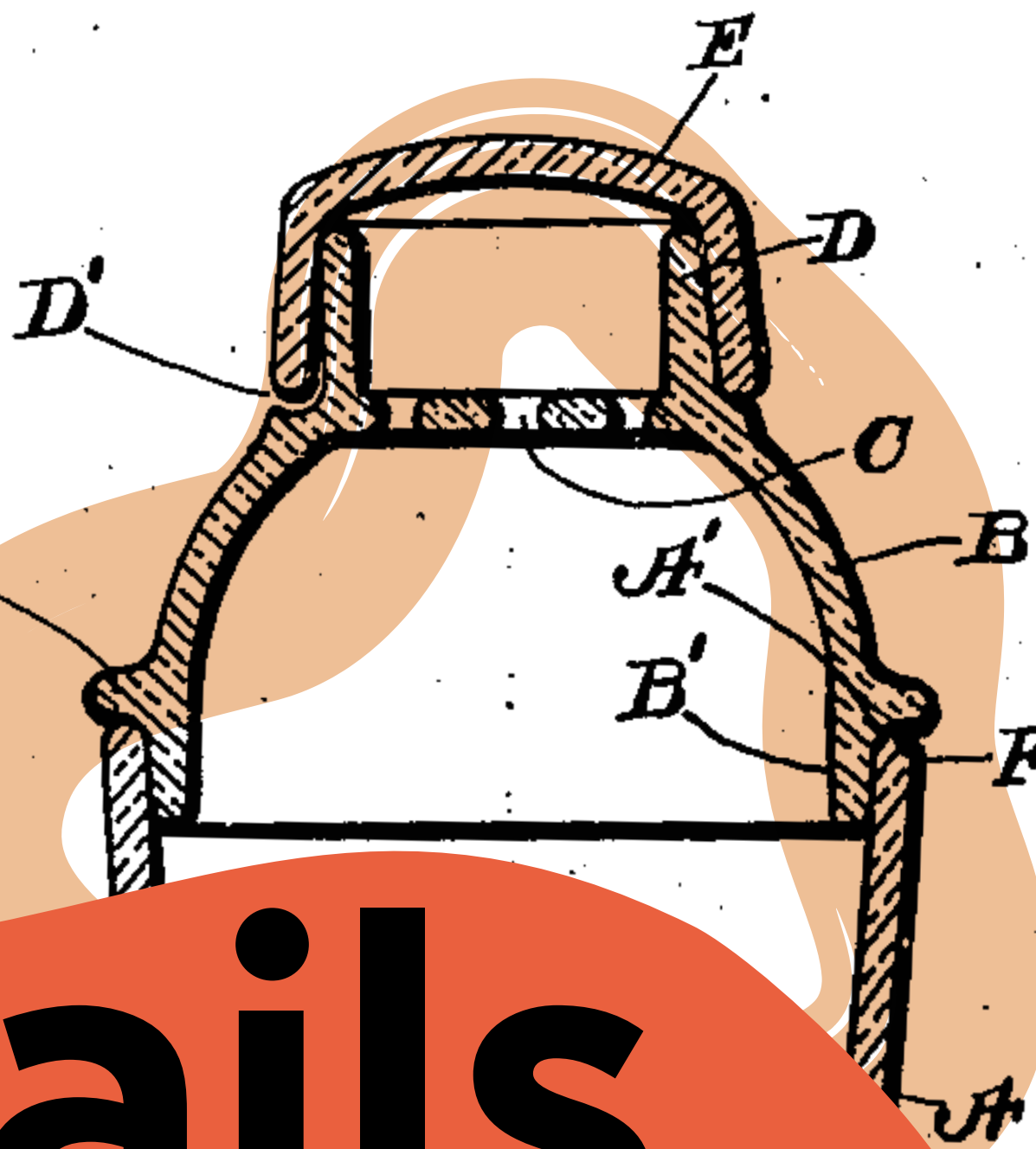

cocktails

classiques

Pimm's Cup	10.00
<i>Pimm's, ginger ale</i>	
Hugo	10.00
<i>Prosecco, menthe fraiche, sirop de fleur de sureau, citron vert</i>	
Aperol Spritz	10.00
<i>Aperol, Prosecco, eau pétillante</i>	
Campari Spritz	11.00
<i>Campari, Prosecco, eau pétillante</i>	
Negroni.....	11.00
<i>Campari, Vermouth rouge, Bombay Sapphire</i>	
Moscow Mule	11.00
<i>42 Below vodka, ginger beer, jus de citron vert</i>	
Dark & Stormy.....	12.00
<i>Bacardi 4 años, ginger beer, jus de citron vert</i>	
Sour & Friend's	11.00
<i>Ton alcool préféré, jus de citron, sucre de canne</i>	
Mojito.....	11.00
<i>Bacardi Carta Blanca, Bacardi 4 años, menthe fraîche, eau pétillante, sucre de canne, jus de citron vert</i>	
Cuba Libre	12.00
<i>Bacardi 4 años, cola, citron vert</i>	
Margarita	12.00
<i>Tequila Cazadores reposado, Cointreau, citron vert</i>	
Caipirinha.....	12.00
<i>Cachaça, sucre de canne, citron vert</i>	



specials

- Pink Lillet & Tonic.....10.00
Lillet Blanc, Fever Tree Raspberry & Rhubarb, citron vert
- Paloma.....12.00
Tequila Cazadores, jus de citron vert, Fever Tree grapefruit
- Bloody Mary12.00
Eristoff Vodka, jus de tomates Big Tom
- Espresso Martini.....12.00
Vodka, liqueur de café, espresso, sirop de sucre

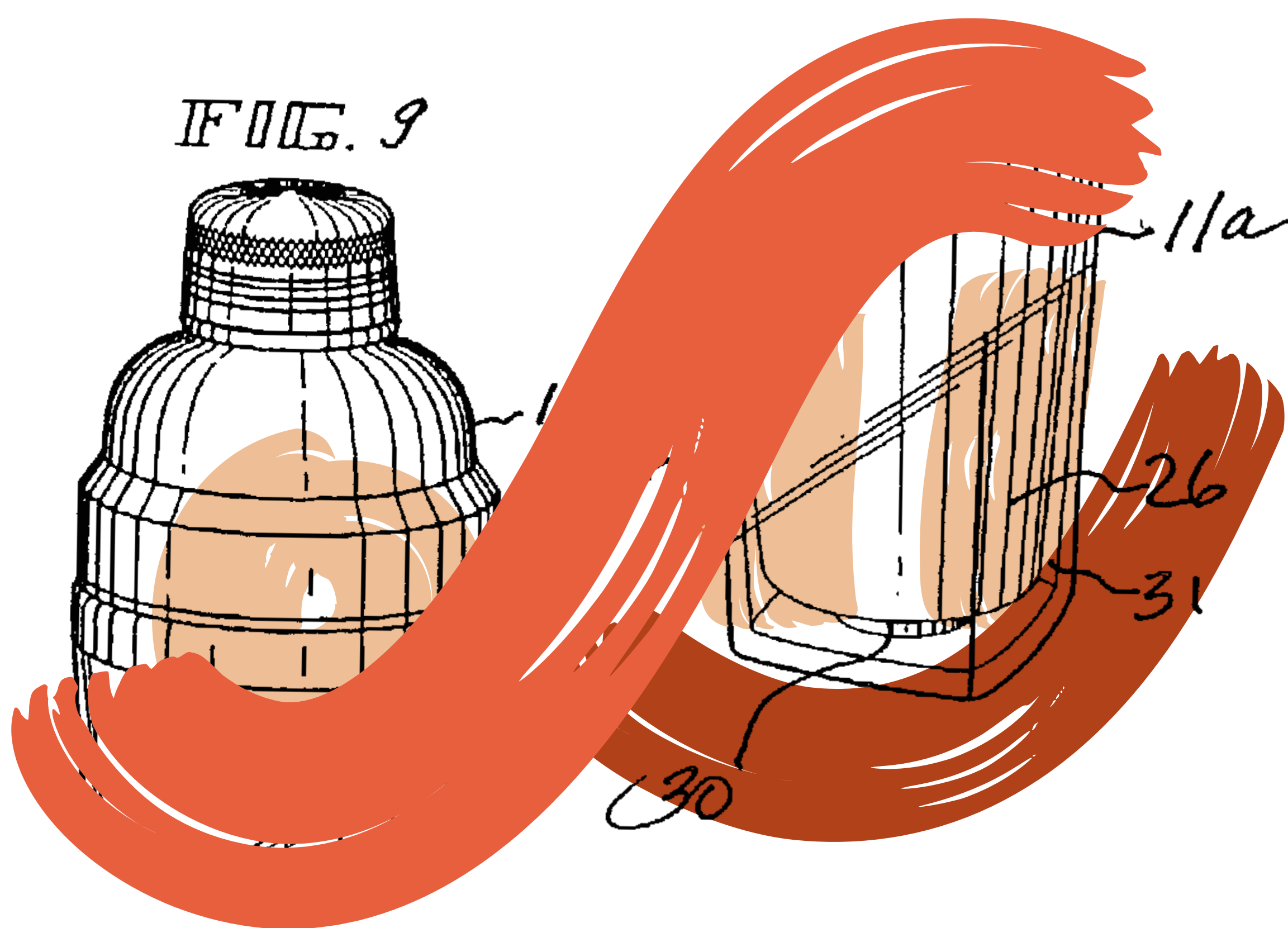

mocktails

- Crodino.....6.00
Aperitivo non alcolico
- Nona Spritz9.00
Non-Alcoholic Blood Orange & Gentian Spritz, Fever tree tonic
- Martini Vibrante9.00
Martini Vibrante, jus de pamplemousse bio, eau pétillante
- Nojito.....8.00
Menthe fraîche, eau pétillante, sucre de canne, jus de citron vert



Fig. 1

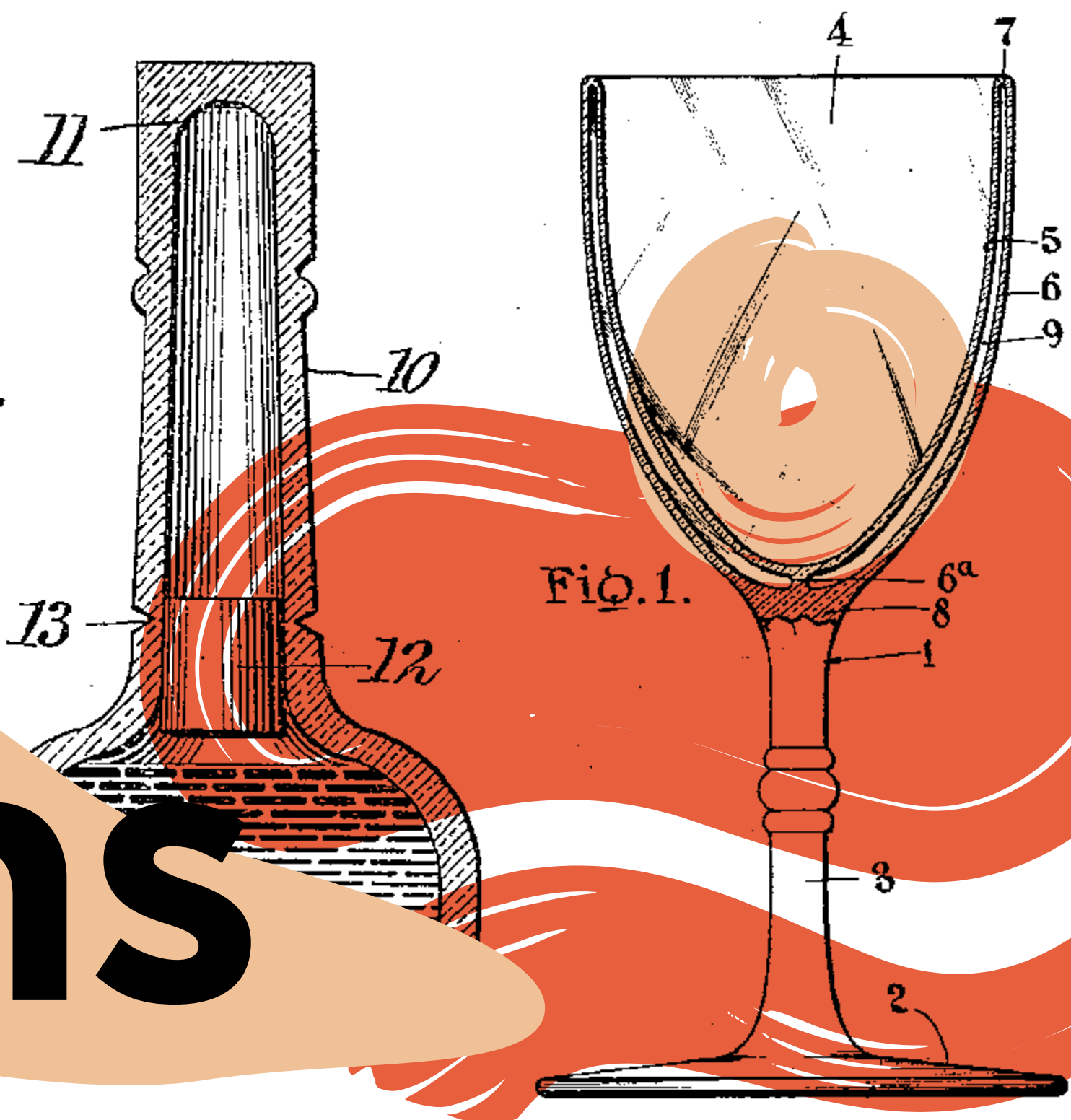

vins

bulles

MOËT & CHANDON 12.00 | 95.00

Champagne

SCAVI & RAY 8.00 | 40.00

Prosecco

CHANDON GARDEN SPRITZ 10.00 | 50.00

Sparkling wine

blanc

LES CISTES 5.50 | 28.00

Languedoc

LES SAUTERELLES 6.00 | 31.00

Loire

LA GRAPPE D'OR 36.00

Pouilly Fumé - Loire

MONTGRAS 33.00

Chardonnay - Chili

PAJZOZ TOKAJ 35.00

Hongrie

PIZZOLATO 34.00

Pinot Grigio - Italie



rosé

CHÂTEAU FAVORI.....5.50 | 28.00

Vard

M de MINUTY..... 36.00

Provence

rouge

PARALLÈLE 455.50 | 30.00

Rhône

ZINIO.....6.00 | 31.00

Rioja -Semi Crianza, Espagne

MONTGRAS31.00

Reserva Carmenère, Chili

SAINT NICOLAS DE BOURGUEIL.....31.00

Loire

PEYBONHOMME-LES-TOURS 33.00

Bordeaux

CHÂTEAU LACOMBE NOAILLAC..... 33.00

Bordeaux, Médoc

ROUGE!34.00

Rhône

PINOT NOIR BOECKEL34.00

Alsace

CHÂTEAU PATACHE D'AUX39.00

Bordeaux, Médoc

CHÂTEAU DE LA COMMANDERIE43.00

Pomerol

GRAND-PEY-LESCOURS.....46.00

Bordeaux, Saint-Emilion

CHÂTEAU PETIT BOCQ55.00

Bordeaux

A

alcools

*1 soft inclus | Red Bull / Fever Tree +1€
bouteilles : 6 softs inclus ou 5 Red Bull/Fever Tree*

vodka

Eristoff White/Red/Passion.....	10.50 100.00
42Below	11.50 110.00
Grey Goose	12.50 120.00

whisky

William Lawson's.....	10.50 100.00
Jack Daniel's.....	11.50 110.00
Dewar's 12 ans.....	12.50
Johnnie Walker Red Label	12.50

gin

Bombay Sapphire Bosford.....	10.50 100.00
Bombay Bramble	11.50
Bulldog The Botanist Gin	12.50
■ Panda Gin.....	12.50
■ Marula.....	12.50
■ Arduenna.....	12.50
Gin Mare Capri	13.50
■ Copperhead.....	13.50



rhum

Bacardi Carta Blanca.....	10.50 100.00
Bacardi Carreabeen Spiced.....	11.50 110.00
Bacardi 4 años	11.50 110.00
Bacardi 8 años	12.50

apéritifs, digestifs

Ricard	6.50
Martini.....	6.50
Limoncello Bongiorno	7.50
Amaretto Adriatico	7.50
Passoã.....	9.50
Get 27	9.50
Jägermeister.....	9.50
Cointreau	10.50

shots 5+1

Kiss Cool	5.00
<i>Vodka, liqueur de menthe, Curaçao</i>	
Shot Maison.....	5.00
<i>shot du moment</i>	
Jäger Bomb.....	6.00
<i>Red Bull, Jägermeister</i>	
Cazadores Reposado	5.00
<i>Tequila</i>	
Patron Silver.....	8.00
<i>Tequila</i>	



bistro
pil
ko

formules pour les groupes

(à ptd 10p. réservation minimum 3 jours avant)

34€ *(formule 2 services)*

• **Mix d'entrées à partager**

Houmous, Portion de Fromage,

Assiette 'Teroir', Nems et Fingers de Volaille

• **Sélection de 3 plats à la carte***

Hors Pizzas et Salade César

• **Dessert au choix (+8€/p)***

**Plat et dessert unique au choix si plus de 30p.*



Pilko fait partie du groupe Tero qui rassemble des activités de team building, des lieux événementiels, des lodges, des clubs de sport et l'organisation de grands événements sportifs.

Quels liens entre ces activités ? Vous offrir des expériences mémorables et générer de l'authenticité à travers le partage !

www.tero.be

partenaires

producteurs :

Fruits & légumes : *ferme des Rabanisse*

Viande : *ferme des Rabanisse,*
boucherie Magerotte

Préparations : *Rocky's, Kaiyou*

Horaire de la cuisine :

Lundi au Jeudi de 18h à 22h

Vendredi et Samedi de 12h à 22h

Les dernières commandes sont prises 15 minutes avant la fermeture de la cuisine.